

# LEDBELYSNING

## Datablad

DALI LED DRIVER – 400W/24V LED DRIVER



Varenummer: 600339

Elektronisk DALI LED-driver med dimmeområde fra 0-100%.

Model	24V DALI LED-driver	Konstantspenning
Inngang	Spenningsområde	180-240V AC
	Frekvens	47-63Hz
	PFC	>0.95 ved full last
	Effektivitet	>90% ved full last
Utgang	Spenning	24V DC
	Presisjon	±0,5V
	Dimming	Ja, via DALI-bus
	Strøm	16,6A
	Effekt	400W
Beskyttelse	Kortslutning	Ja
	Overspenning	Ja, <265V AC
	Beskyttelsesgrad	IP67
Omgivelse	Temperatur	-40 til 60°C
	Fuktighet	20-90%
	Lagring	-40 til +80°C og 10-95% RH
Sikkerhet og EMS	Standard	Refererer til EN61347-1 og EN61347-2-13
	Motstandsspenning	I/P-O/P:3,75KV AC
	Isolasjonsstyrke	I/P-O/P:400M Ω/500 VDC/25°C/70%RH
	EMS utslipp	Korresponderer med EN55015, EN61000-3-2 (≥50% last)
Andre	Vekt	2300 gram
	Dimensjoner	285*95*50mm (L*B*H)
	PCB	94V-0
	Farge	Mørkegrå
	Vedlikehold	Ingen



# LEDBELYSNING

## Datablad

Skisse

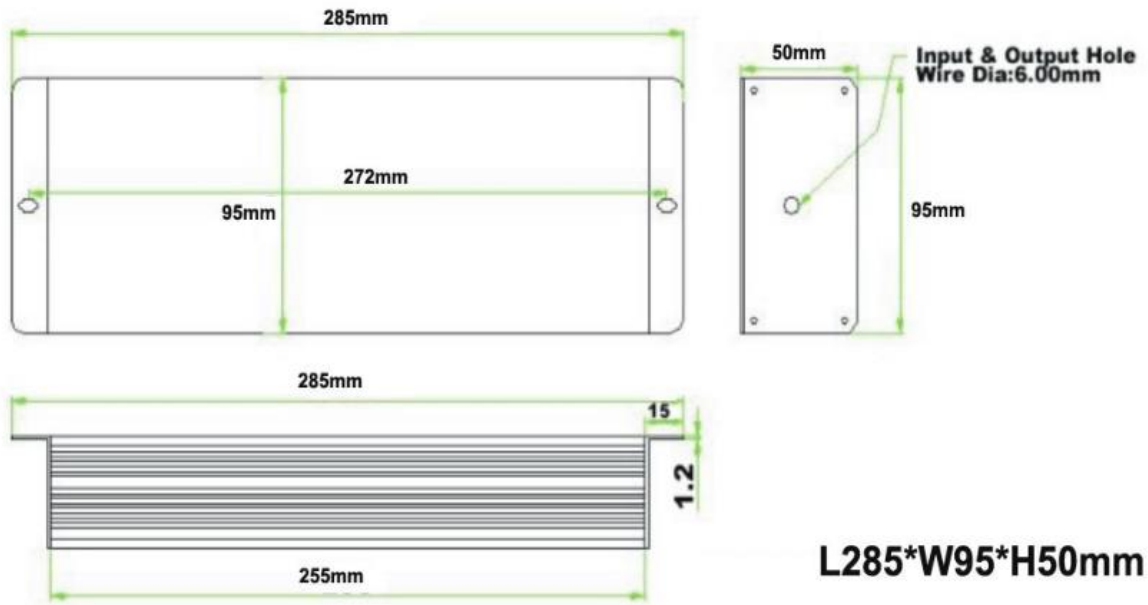

Koblingskjema dimmer via DALI

